

ALBION XL

VERSATILE TRANSPORTER

KELT XXL

MULTIPURPOSE LOADING

SEMI-TRAILER





Reliable transportation is one of the main factors for successful and profitable harvest. It is really important for farmer to have modern high quality and cost-effective trailers with versatile and safe characteristics.

LOZOVA MACHINERY pays much attention to the state-of-art technologies and studies market needs, investing in innovative developments and researches.

In 2016 we assured that there is lack of high quality agricultural trailers in Ukraine, we have developed the latest ALBION XL trailer carrier.

The first trailer produced in the framework of this cooperation is ALBION XL, adapted to Ukrainian, as well as Europe and CIS markets.

Overall dimensions of ALBION XL fully correspond to road laws of Ukraine and EU.

ALBION XL was designed taking into account the world tendencies of energy-efficiency. Most of farmers still use old equipment and lose about 5-10% of harvest during transportation. Many of them even use commercial vehicles which compact the soil and cause loss of harvest and soil fertility. LOZOVA MACHINERY trailers cope with these problems.



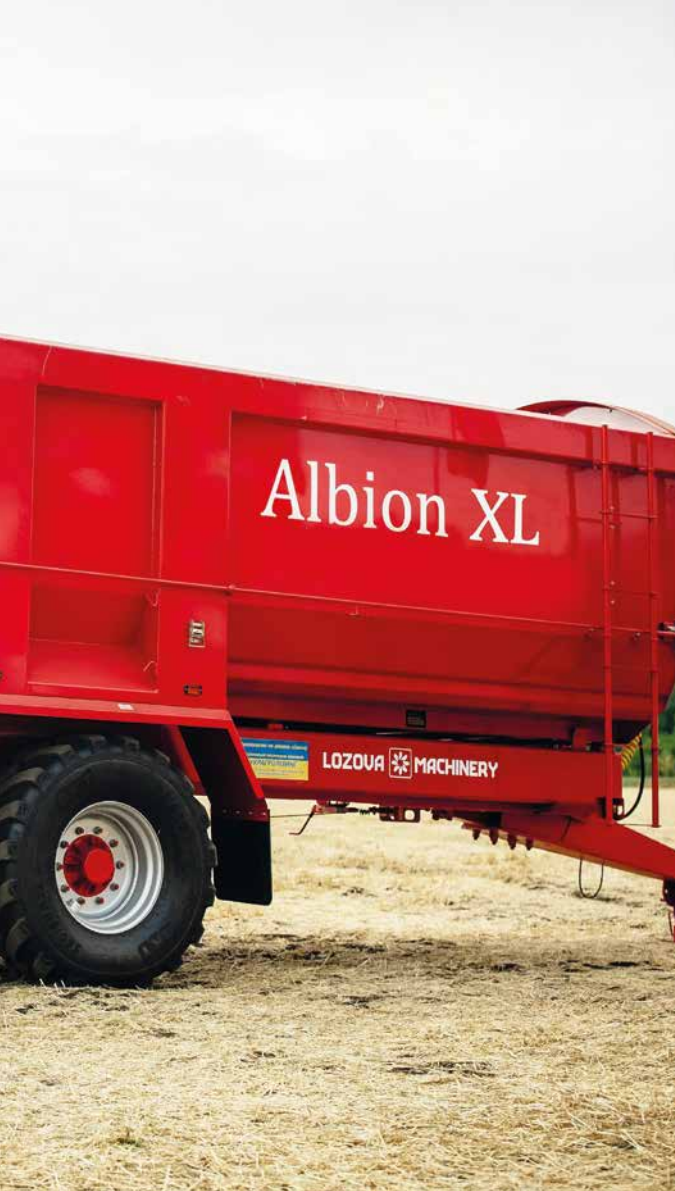

ALBION XL – two-axle dumping semi-trailer with modernized chassis, with a volume of 26 m³ (with additional sides – 37 m³) and load capacity of 20 t.

Trailer is used for transportation of various cargo – cereals, root crops, ensilage, chip stones, as well as for the fast unloading, due to British engineering principles:

Dumping platform is solid-metal and gutter-shaped. Body curved sides prevent sticking of cargo in area of bottom and side mating, which makes unloading easier and faster.

Trailer, equipped with screw conveyor, may be used as conveyor hopper (full unloading in 2-3 minutes).

For transportation by hard surface roads you can change tires type and size.

**Three basic designs are available:
CLASSIC, PRESTIGE and PREMIUM.**



26 m³, 37 m³



20 t



min 150 hp

ONE OF THE MOST ROBUST BODIES IN THE CLASS

Sides thickness - 4 mm, bottom thickness - 6 mm.



PROTECTIVE COVER



All trailers (except of trailers with screw conveyor and additional sides) can be equipped with manually-driven protective cover. Folded cover is fixed on the left side.

CONVENIENT OVERVIEW

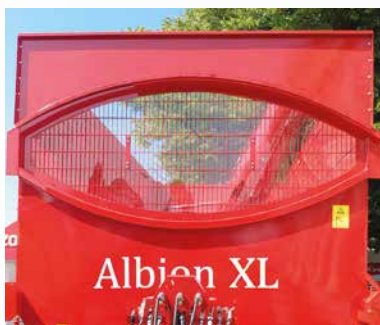

Front big window ensures convenient visual control of trailer loading from tractor cab.

VERSATILE COUPLING

Support with hydraulic adjustment of coupling unit height makes coupling with various tractors easier.

Draw bar has step height adjustment which makes it suitable for tractors with different heights of coupling.

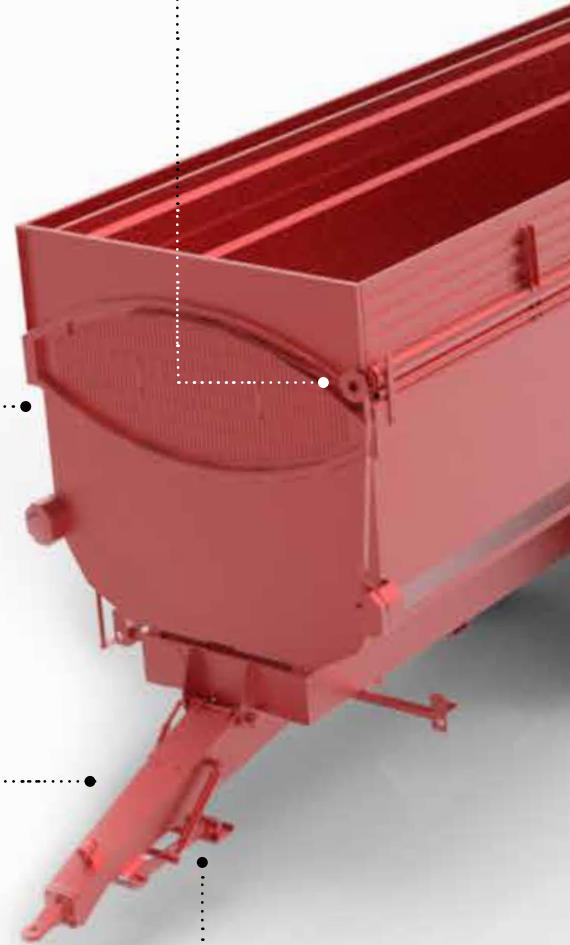

Spring-loaded draw bar reduces dynamic loading during drive/brake.

PERFECT LIGHTING AND VIDEO CONTROL



Camera and lighting on screw conveyor

Allow to control even distribution of cargo during unloading.

Rear external lighting and rearview camera

Additional lighting and video camera option which enables safe maneuvering (reverse movement) at night-time.

Internal body lighting

Additional lamp allows to check cargo condition at night-time.

Internal camera

Consists of two components – video camera and screen in tractor cab, allows to control screw conveyor loading with raised body.

CONVINIENT TAIL GATE WITH HYDRAULIC DRIVE

Tail gate opens to 90° and has a metering opening with stopper (rack-and-gear drive makes opening much easier).

It is also equipped with simple and reliable locking system.

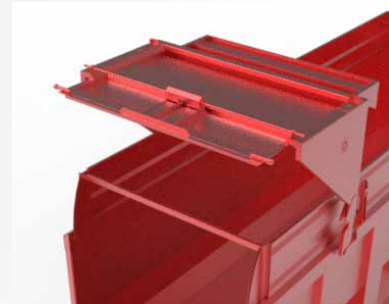

OFF-ROAD TIRES



Basic design PRESTIGE includes 560/60R22,5 tires axles 150x150, with reinforced springs with 100 mm width. Carrying capacity is 20 tons*, and 11,5 tons on public roads.

Wide-section tires provide low pressure on soil and improved off-road capability, especially on soft soil.

Special thread pattern allows to work in waterlogged conditions without wheels clogging.

*Load capacity on public roads is limited by axle load rate allowed in the country of use.



SCREW CONVEYOR

Allows to unload full trailer in 2-3 minutes.

To be used as conveyor hopper ALBION XL can be equipped with demountable screw conveyor which doesn't extend beyond the trailer in transport position.

With this unit trailer can transport and unload bulk cargo by dumping. Screw is rotated by hydraulic motor and supplied from tractor hydraulic system. If tractor hydraulic power is not enough (less than 150 l/min), trailer can be equipped with additional PTO driven hydraulic pump. Folding mechanism is controlled from tractor cab.



ADDITIONAL SIDES

Increase trailer volume up to 37 m³ and improve efficiency during transportation of low-density cargo: sunflower seeds, ensilage, hay etc.

Additional sides are demountable and can be mounted on trailers in all available designs (Classic, Prestige, Premium).

TECHNICAL CHARACTERISTICS

	ALBION XL
Maximum weight with cargo, kg	27 500
Semi-trailer weight, kg	7500
Load capacity, t	20
Useful capacity, m ³ : - base - with additional sides	26 37
Axles, pcs.	2
Brake system	pneumatic
Load on draw bar, kg	3 500
Load on axle, kg	12 050
Tires	BKT FL 630 Plus
Tractor power, hp	min 150
Screw conveyor -diameter, mm -unloading efficiency, t/h -complete unloading time with volume 26 m ³ , min -complete unloading time with volume 37 m ³ , min	550 540 2,5 3,6
Overall dimension (length x width x height), mm (height with sides), mm	8847× 2600 × 3396 3675

MAKE YOUR OWN DESIGN!



Additional units	CLASSIC	PRESTIGE	PREMIUM
Tires 560/60R22,5	●	●	●
Reinforced axle (150x150)	●	●	●
Reinforced suspension with spring 100 mm	●	●	●
Service brakes with pneumatic drive	●	●	○
Service brakes with combined pneumatic and hydraulic drive	○	○	●
Lighting with incandescent lamps	●	○	○
Lighting with LED lamps	○	●	●
Front window	○	●	●
Internal lighting	○	◐	●
Internal camera	○	◐	●
Rear external lighting	○	◐	●
Rear external video camera	○	◐	●
Screw lighting	○	◐	●
Screw video camera	○	◐	●
Manually driven cover	◐	●	○
Additional sides	◐	◐	◐
Screw conveyor	○	◐	◐
Weight measuring system with printer output	○	◐	○
Weight measuring system with GPRS data output	○	◐	●

● equipped

◐ optionally equipped

○ not equipped



KELT XXL

MULTIPURPOSE LOADING
SEMI-TRAILER





Tractor multipurpose loading semi-trailer KELT XXL is designed for transportation of agricultural cargo by hard-surface roads, earth roads, fields and cross-country, except of waterlogged areas.

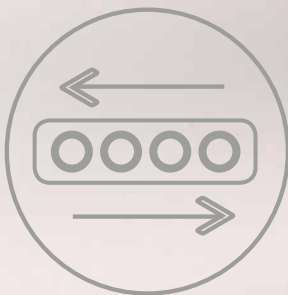

Trailer is unloaded by means of closed conveyor belt.

One of the KELT XXL features is three-axle chassis which provides low unit pressure on soil (tire pressure is 2,2 atm) and maximum axial load allowing to use fully loaded trailer on public roads.

With additional equipment KELT XXL is capable to unload grain, spread fertilizers and much more.



28 m³, 36 m³, 43 m³



28 t



min 170 hp

The only and full compliance with road laws of Ukraine and EU countries in terms of dimensions and load on axle!



MAXIMUM COST-EFFECTIVENESS

KELT XXL has no separate frame and consists of integral body with mounted elements of chassis and pivoting bogie, which provides sufficient durability with low weight.

MANEUVERABILITY

Design of chassis with front pivoting bogie enables easier maneuvering on limited work sites.



OFF-ROAD CAPABILITY AND REDUCED FUEL CONSUMPTION

Trailer can be equipped with tire pressure regulation system (up to 4 atm) which works during movement and increases off-road capability, as well as reduces fuel consumption.



ADDITIONAL SIDES

Trailer can be equipped with two sets of additional sides with height of 400 and 800 mm. With additional sides trailer volume will be 36 and 43 m³ correspondingly.

28 m³, 36 m³, 43 m³



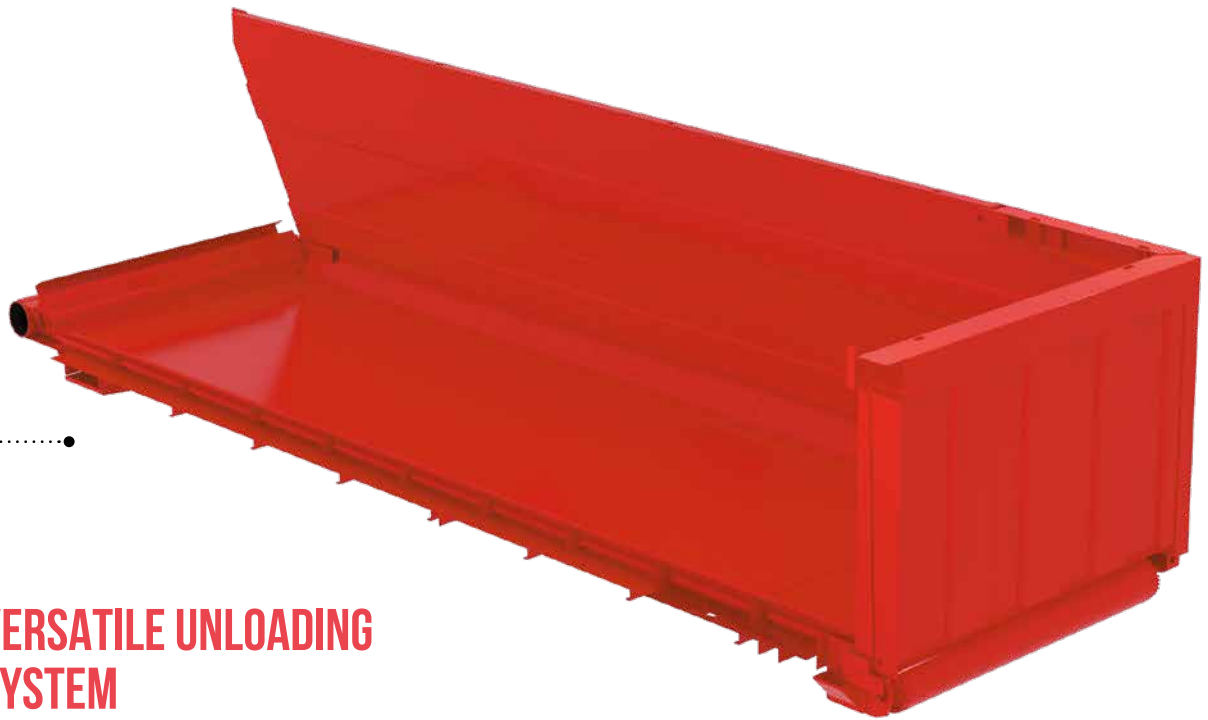

VERSATILE UNLOADING SYSTEM

Trailer is unloaded by means of belt conveyor with width equal to body bottom width. Belt bears on the body bottom. Conveyor drive drum is rotated by hydraulic motor.

Friction between bottom and conveyor belt is reduced by the air lubrication system.

Conveyor unloading allows to mount additional equipment.

Such system allows to unload semi-trailer in low ceiling hangars, on uneven ground and during movement.

SCREW CONVEYOR

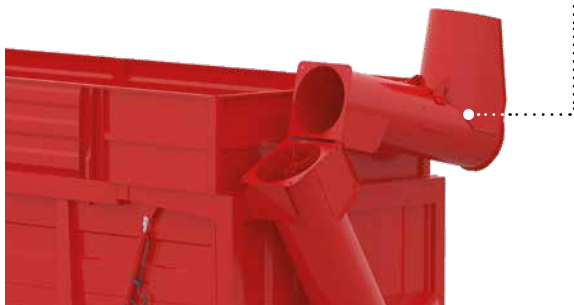

Screw conveyor is mounted instead of tail gate on its fittings. Mounting is very simple.

Semi-trailer (21 t) full unloading time is 3 minutes maximum.

Unloading can be performed on non-prepared sites and during movement. In transport position screw conveyor is folded across the body and not extends beyond it.

VERSATILITY



Trailer and pivoting bogie are joined by means of standard bolster, which enables to transport trailer by tractor trucks and to use pivoting bogie for this purpose.

Due to its design trailer can be coupled with tractor by means of towing eye of 50 mm or 90 mm, and drawbar allows to change towing eye during operation.

FERTILIZERS SPREADER



Spreader is easily mounted instead of tail gate. Horizontal beaters and spreading plates and driven by tractor hydraulic system.

CONVINIENCE

KELT XXL is equipped with convenient ladder (height from first stair to bottom is no more than 400 mm) which is folded up in transport position and not obstruct bogie pivoting.

Ladder stairs have nonslipping surface. There is a big window covered with transparent plastic on the body front, which ensures good view inside the body.



TECHNICAL CHARACTERISTICS

	KELT XXL
Loading capacity, t	21
Useful capacity, m ³ : - base - with additional sides of 400 mm - with additional sides of 800 mm	28 36 43
Unloading time, min	2
Transport speed by hard surface roads, km/h	40
Transport speed by soil, km/h	20
Number of axles, pcs.	3
Body internal dimensions, mm: - length - width - height - height to body bottom - height with sides of 400 mm - height with sides of 800 mm	7 500 2 200-2 325 1 600 1 400 2 000 2 400
Basic design weight, kg	6 200
Full unladen weight, kg	27 500
Axle load, kg	8 000
Vertical load on tractor coupler, kg	3 500
Overall dimension in transport position, mm: - length - width - height - height with sides of 400 mm - height with sides of 800 mm	10 000 2 550 3 000 3 400 3 800
Off-road features: - road clearance, mm - rear overhang angle, (значок градуса) - allowed tire pressure at full load, MPa - allowed maximum tire pressure, MPa - maximum tire pressure change time, min - minimum turning radius, m	480 42 11 0,24 0,41 2 7



MAKE YOUR OWN DESIGN!

Additional units	CLASSIC	PRESTIGE	PREMIUM
Tire pressure regulation system	<input type="radio"/>	<input checked="" type="radio"/>	<input checked="" type="radio"/>
Lighting technology with incandescent lamps	<input checked="" type="radio"/>	<input type="radio"/>	<input type="radio"/>
Lighting technology with LED lamps	<input type="radio"/>	<input checked="" type="radio"/>	<input checked="" type="radio"/>
Brake system with pneumatic drive	<input checked="" type="radio"/>	<input checked="" type="radio"/>	<input type="radio"/>
Brake system with combined pneumatic and hydraulic drive	<input type="radio"/>	<input type="radio"/>	<input checked="" type="radio"/>
Outrigger set for body	<input type="radio"/>	<input type="radio"/>	<input checked="" type="radio"/>
Manually driven tent	<input checked="" type="radio"/>	<input type="radio"/>	<input type="radio"/>
Tent driven from tractor cab	<input type="radio"/>	<input checked="" type="radio"/>	<input checked="" type="radio"/>
Hydraulic distributor with electric control from tractor cab	<input type="radio"/>	<input type="radio"/>	<input checked="" type="radio"/>
Hydraulic power station driven by tractor PTO shaft	<input type="radio"/>	<input type="radio"/>	<input type="radio"/>
Unloading and additional equipment remote control system	<input type="radio"/>	<input type="radio"/>	<input checked="" type="radio"/>
Additional equipment and background video observation system	<input type="radio"/>	<input type="radio"/>	<input checked="" type="radio"/>
Weight measuring system with printer output	<input type="radio"/>	<input checked="" type="radio"/>	<input type="radio"/>
Weight measuring system with GPRS data output	<input type="radio"/>	<input type="radio"/>	<input checked="" type="radio"/>
Tail gate with window for dosated unloading	<input type="radio"/>	<input checked="" type="radio"/>	<input checked="" type="radio"/>
Air compressor driven by hydraulic motor for supplying tire pressure change system and conveyor belt air lubrication	<input type="radio"/>	<input type="radio"/>	<input checked="" type="radio"/>
Road tires	<input checked="" type="radio"/>	<input type="radio"/>	<input type="radio"/>
Multi-purpose tires	<input type="radio"/>	<input checked="" type="radio"/>	<input checked="" type="radio"/>
Body front window	<input type="radio"/>	<input checked="" type="radio"/>	<input checked="" type="radio"/>
Additional sides of 400 mm	<input type="radio"/>	<input type="radio"/>	<input type="radio"/>
Additional sides of 800 mm	<input type="radio"/>	<input type="radio"/>	<input type="radio"/>
Screw conveyor	<input type="radio"/>	<input type="radio"/>	<input type="radio"/>
Fertilizers spreader	<input type="radio"/>	<input type="radio"/>	<input type="radio"/>

equipped

optionally equipped

not equipped



LOZOVA MACHINERY

UPEC TRADING – official distributor
of LOZOVA MACHINERY

4, Marshal Batitskiy Str.
Kharkov, 61038, Ukraine

phone.: +38 057 738 10 14
+38 057 738 10 43

agro@lozovamachinery.com
www.lozovamachinery.com

